

EN

# Flow Meter 4A

## Assembly and Operation Instructions

# Contents

<b>1 General information</b> .....	<b>3</b>
1.1 Introduction .....	3
1.2 Warnings .....	3
1.3 Special Hazards .....	3
1.4 General Safety Instructions .....	3
1.5 Designated Use .....	3
1.6 Reasonably Foreseeable Misuse .....	3
<b>2 Manufacturer's Specification</b> .....	<b>4</b>
2.1 Description .....	4
2.2 Transport and Storage .....	4
<b>3 Technical Data</b> .....	<b>4</b>
3.1 Dimensions .....	4
3.2 Operating Medium .....	4
3.3 Pressure Guide .....	4
3.4 Measuring Ranges .....	5
<b>4 Assembly and Operation</b> .....	<b>5</b>
4.1 Assembly Instructions .....	5
4.2 Tools Required .....	5
4.3 Connect Flow Meter .....	5
<b>5 Commissioning</b> .....	<b>5</b>
5.1 Precondition for Commissioning .....	5
5.2 Operation .....	5
5.3 Reading the Measured Value .....	5
<b>6 Maintenance</b> .....	<b>6</b>
<b>7 Disposal</b> .....	<b>6</b>
<b>8 Return Delivery</b> .....	<b>6</b>
<b>9 Troubleshooting / Fault Rectification</b> .....	<b>6</b>
<b>10 Questions and Suggestions</b> .....	<b>6</b>
<b>11 Manufacturer's Declaration</b> .....	<b>6</b>





## 1. General information

### 1.1 Introduction

- These instructions apply to series 4A flow meters, also referred to below as fittings.
- Read the instructions completely before using our products to prevent injuries, material damage and malfunctions!
- Save the instructions for later reference.
- All rights including copyright and industrial property rights are explicitly reserved.

### 1.2 Warnings

- Warnings are always identified by a signal word. The following signal words or hazard levels are used:

 Danger	<b>Danger:</b> Failure to follow instructions will lead to serious injuries or death. High risk level of endangerment.
 Warning	<b>Warning:</b> Failure to follow instructions may lead to serious injuries or death. Moderate risk level of endangerment.
 Caution	<b>Caution:</b> May lead to slight or moderate injuries. Low risk level of endangerment.
	<b>Note:</b> Refers to an instruction that must absolutely be followed.
	<b>Information:</b> Gives useful tips and recommendations..

### 1.3 Special Hazards



- It must be ensured that the fitting is resistant for the media and temperatures that will be used. The resistance of the fitting with aggressive media depends in individual cases on many variables (such as the temperature, concentration ratio of the medium, material, environment, tube material etc.). The person ordering the fitting is responsible for checking for the specific application. In case of doubt install the fitting on a trial basis.



- Always comply with the safety data sheets or the safety requirements for the media you are using!



- Before removing the fitting it must be ensured that there is no more medium in the flexible tube/pipe system and the pressure has completely dissipated. Exercise caution for toxic, corrosive or hot media residue flowing out of the line or remaining in dead spaces.

### 1.4 General Safety Instructions

- The fitting must be properly connected to the flexible tube/pipe system.
- Before installing the fitting make certain that external mechanical effects such as thrust and bending forces are not acting on the flexible tube/pipe system.
- Installation, commissioning, operation, installation, maintenance, troubleshooting and disassembly must only be performed by qualified specialists with due consideration of accident prevention regulations. Personnel must be capable based on their technical training and experience of performing assembly tasks, following technical specifications and recognizing possible dangers.
- Personnel with deficient knowledge must be trained and instructed.
- Areas of responsibility and responsibilities must be precisely regulated and personnel must be monitored.

These safety instructions do not take into consideration any:

- Coincidences and events that could occur at the customer location during assembly, operation and maintenance.
- Local safety requirements, for which the operating company is responsible to ensure compliance, including assembly personnel who are used.

### 1.5 Designated Use

- The fitting must only be operated within the permitted usage ranges for pressure and temperature.
- Only the operating media named in the documentation are permitted to flow through the fitting.
- The fitting must only be operated if it is in flawless technical condition.
- The fitting must not be operated if it is in partially assembled condition.
- If other operating modes are not named in the documentation, they must be approved with the manufacturer.



### 1.6 Reasonably Foreseeable Misuse

- Any usage other than designated use.
- Do not make any modifications to the product by yourself!
- Components should only be retrofitted after consultation with the manufacturer.



## 2 Manufacturer's Specification

### 2.1 Description

The flow meters 4A are used for the safe measurement and regulation of media flows. They are suitable for installation in switch panels and for wall mounting.

### 2.2 Transport and Storage

- The fitting must be protected against mechanical damage, moisture, dirt and dust. The storage temperature range is 10 – 40°C.
- Avoid UV radiation and direct sunlight.
- Leave the fitting in its original packaging to ensure the best possible protection.
- Dispose of the packaging material according to disposal requirements/environmental protection regulations.



Warning

## 3 Technical Data

### 3.1 Dimensions

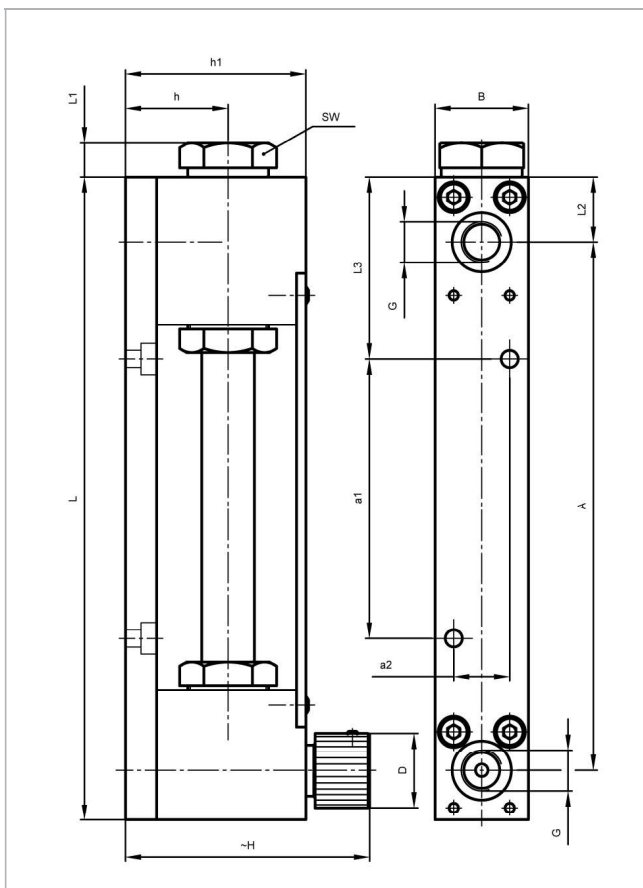

	G / NPT	L	L1	L2	L3	A	a1
4A100.../ 4A101...	1/4"	207	10	21	58.5	170	90
4A200.../ 4A201...	1/4"	207	11	21	58.5	170	90

	a2	B	~H	h	h1	ØD	SW
4A100.../ 4A101...	18	30	78.5	33	58	24	SW19
4A200.../ 4A201...	18	30	78.5	33	58	24	SW27

All information in mm

Missing dimensions can be found on our homepage under the following link: [www.em-technik.com](http://www.em-technik.com)

Special sizes can be asked via [info@em-technik.com](mailto:info@em-technik.com)

### 3.2 Operating Medium

- Neutral, gaseous and liquid media that do not negatively affect the physical and chemical properties of the relevant housing and sealing material.
- If you have questions about resistance please contact emtechnik.
- For the maximum permitted operating pressure/temperature see the pressure guide.

### 3.3 Pressure Guide

As the temperature rises, the effectiveness of the fitting falls, as shown by this table.

Material	PVDF	PTFE
Pressure Stage	PN 3	PN 3
-40°C	75%	75%
-20°C	100%	100%
5°C	100%	100%
20°C	100%	100%
30°C	80%	80%
40°C	70%	70%
50°C	60%	60%
60°C	50%	50%
70°C	45%	40%
80°C	40%	30%
90°C	35%	30%
100°C	35%	30%

Material	PVDF	PTFE
Pressure Stage	PN 3	PN 3
110°C	30%	25%
120°C	25%	25%
130°C	25%	25%
140°C	10%	20%
150°C		10%

### 3.4 Measuring Ranges

- Measuring ranges will be manufactured and calibrated according to the individual customer specifications.
- To order following information are required: Medium, pressure, temperature, measuring range, viscosity and density.

## 4 Assembly and Operation

### 4.1 Assembly Instructions

- Make certain the fitting is suitable for the relevant application. The fitting must be suitable for the operating conditions of the pipeline system (medium, concentration, temperature and pressure) as well as the relevant ambient conditions.
- Check the fitting for transport damage before installing it. If the fitting is damaged do not install it.
- The planner, the construction company or operating company are responsible for the positioning and installation of the fitting. Planning and installation errors can adversely affect the reliable functionality of the fitting and may represent a significant potential for hazard.
- After the fitting is installed perform a tightness and function check.



Warning



Warning

### 4.2 Tools Required

The tools required for installation and assembly are not included with delivery.

### 4.3 Connect Flow Meter

- The flow meter must be connected to the pipeline so it is free of mechanical stress.
- The flow meter has a female thread (ISO, DIN, ANSI) and can be connected with various connecting elements of the emtechnik system.
- Observe the flow direction from the bottom to the top.

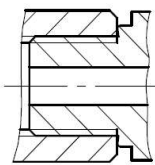
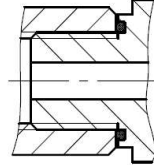
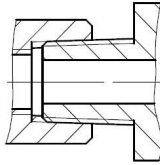

Warning

Cylindrical thread	Conical thread	
Sealing is provided by a sealing collar for Cylindrical threads (G, M or UNF). A version with an O-ring is also possible.	Sealing is provided by the thread itself for Conical threads (NPT).	
Sealing Collar	O-Ring	Thread
		

- Each thread must always be connected with the same thread type.
- If a plastic fitting is used in combination with a metallic male fitting, additional sealing with Teflon® tape is recommended.



## 5 Commissioning

### 5.1 Precondition for Commissioning

- Protect against leaks: Take protective measures against exceeding the maximum permitted pressure due to possible pressure surges.
- Check the tightness and function of the fitting.
- In new systems and after repairs, flush the line system to remove foreign materials.



Warning

### 5.2 Operation

The series 4A flow meter has an integrated fine regulating valve. Turn the handwheel clockwise to reduce the flow. Turn the handwheel counter-clockwise to increase the flow.

### 5.3 Reading the Measured Value

- The position of the float in the metering tube corresponds to the volumetric flow of the medium.
- Parallax-free reading: Look over the top edge of the float and read the measured value on the scale.

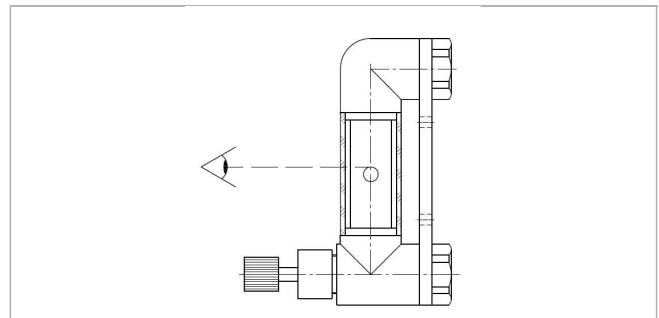

## 6 Maintenance

- When used as designated, the fitting is practically wear-free and generally requires no maintenance.
- The operating company must perform regular visual inspections of the fitting according to the operating conditions to prevent leaks and damage.

## 7 Disposal

- When disposing of the fitting and packaging, comply with the relevant disposal requirements and environmental protection regulations.
- When disposing of fittings, pay careful attention to any residues of toxic or corrosive media.



Warning

## 8 Return Delivery



Do not return before consulting with **emtechnik**.

1. Please consult with **emtechnik**.
2. Empty the fitting properly.
3. Rinse and clean the fitting thoroughly, especially if the media is being conveyed are harmful, explosive, hot, or hazardous in some other way.
4. For fittings that have been operated with aggressive, corrosive, combustible, toxic or water polluting media, a completely filled in clearance certificate must always be included.

## 9 Troubleshooting / Fault Rectification

Error	Possible Cause	Error Rectification
The fitting does not open/close or not completely	Foreign object in the fitting	Flush the fitting
Connection between fitting and pipeline is leaking	Sealing surface damaged	Use sealant, see 4.3
Fitting is leaking	Fitting faulty	Check fitting for damage and replace it if necessary

## 10 Manufacturer's Declaration

- Our products do not fall under the scope of the Machinery Directive 2006/42/EC. However, they can be incorporated in an installation that is considered as machinery. In this case regard the following note: The products may not be put into operation until it is made sure that the final machinery into which our products are incorporated complies with the provisions of the Machinery Directive 2006/42/EC.
- Based on the fluid class, pressure and nominal diameter, our products fall under diagram 8 of the Pressure Equipment Directive PED 2014/68/EU. Because of the ratio of nominal diameter, pressure and volume, they fall only under article 4 paragraph 3 and are designed and manufactured according to applicable good engineering practice. They must not carry any CE marking.
- The warranty of armature expires in the following cases: Operating conditions which do not follow the intended use or do not follow technical specifications. Improper installation or assembly. Just as well as inappropriate use, dismantling or modification.
- Failure to observe information provided here may lead to injuries, material damage, malfunctions and impurities due to escaping medium.



Warning

## 11 Contact

In case of questions or suggestions please contact us:

### EM-Technik GmbH

Industriestr. 2

Tel +49 6237 407-0

67133 Maxdorf

Fax +49 6237 407-77

Germany

info@em-technik.com