

EN

Transmitter Valve 5A

Assembly and Operation Instructions

Contents

1 General information	3
1.1 Introduction.....	3
1.2 Warnings	3
1.3 Special Hazards	3
1.4 General Safety Instructions	3
1.5 Designated Use.....	3
1.6 Reasonably Foreseeable Misuse	3
2 Manufacturer's Specification	4
2.1 Description	4
2.2 Transport and Storage.....	4
3 Technical Data	4
3.1 Dimensions 5A630	4
3.2 Operating Medium	4
3.3 Pressure Guide	5
4 Assembly and Operation	5
4.1 Assembly Instructions.....	5
4.2 Tools Required	5
4.3 Connecting the Transmitter Valve	5
5 Commissioning	5
5.1 Precondition for Commissioning.....	5
5.2 Operation.....	5
5.3 Diagram	6
6 Maintenance.....	6
7 Disposal	6
8 Return Delivery	6
9 Troubleshooting / Fault Rectification	6
10 Manufacturer's Declaration	6
11 Contact.....	7





1. General information

1.1 Introduction

- These instructions apply to series 5A transmitter valves, also referred to below as fittings.
- Read the instructions completely before using our products to prevent injuries, material damage and malfunctions!
- Save the instructions for later reference.
- All rights including copyright and industrial property rights are explicitly reserved.

1.2 Warnings

- Warnings are always identified by a signal word. The following signal words or hazard levels are used:

 Danger	Danger: Failure to follow instructions will lead to serious injuries or death. High risk level of endangerment.
 Warning	Warning: Failure to follow instructions may lead to serious injuries or death. Moderate risk level of endangerment.
 Caution	Caution: May lead to slight or moderate injuries. Low risk level of endangerment.
 Note	Note: Refers to an instruction that must absolutely be followed.
 Information	Information: Gives useful tips and recommendations..

1.3 Special Hazards



Danger

- It must be ensured that the fitting is resistant for the media and temperatures that will be used. The resistance of the fitting with aggressive media depends in individual cases on many variables (such as the temperature, concentration ratio of the medium, material, environment, tube material etc.). The person ordering the fitting is responsible for checking for the specific application. In case of doubt install the fitting on a trial basis.



Warning

- Always comply with the safety data sheets or the safety requirements for the media you are using!



Warning

- Before removing the fitting it must be ensured that there is no more medium in the flexible tube/pipe system and the pressure has completely dissipated. Exercise caution for toxic, corrosive or hot media residue flowing out of the line or remaining in dead spaces.

1.4 General Safety Instructions

- The fitting must be properly connected to the flexible tube/pipe system.
- Before installing the fitting make certain that external mechanical effects such as thrust and bending forces are not acting on the flexible tube/pipe system.
- Installation, commissioning, operation, installation, maintenance, troubleshooting and disassembly must only be performed by qualified specialists with due consideration of accident prevention regulations. Personnel must be capable based on their technical training and experience of performing assembly tasks, following technical specifications and recognizing possible dangers.
- Personnel with deficient knowledge must be trained and instructed.
- Areas of responsibility and responsibilities must be precisely regulated and personnel must be monitored.

These safety instructions do not take into consideration any:

- Coincidences and events that could occur at the customer location during assembly, operation and maintenance.
- Local safety requirements, for which the operating company is responsible to ensure compliance, including assembly personnel who are used.

1.5 Designated Use

- The fitting must only be operated within the permitted usage ranges for pressure and temperature.
- Only the operating media named in the documentation are permitted to flow through the fitting.
- The fitting must only be operated if it is in flawless technical condition.
- The fitting must not be operated if it is in partially assembled condition.
- If other operating modes are not named in the documentation, they must be approved with the manufacturer.



Danger

1.6 Reasonably Foreseeable Misuse

- Any usage other than designated use.
- Do not make any modifications to the product by yourself!
- Components should only be retrofitted after consultation with the manufacturer.



2 Manufacturer's Specification

2.1 Description

Transmitter valves of serie 5A are special valve blocks. They provide the safe connection of system pipes to differential pressure transducers (transmitters).

Two designs are available:

- The valve blocks with 3 valves are suitable for shutting off and for pressure compensation in one block. Direct assembly on differential pressure transmitters is possible (DIN EN 61518).
- Shut off, pressure compensation, test and draining in one block – the valve blocks with 5 valves are suitable for a wide range of applications. They are also suitable for direct assembly to differential pressure transmitters (DIN EN 61518).

2.2 Transport and Storage

- The fitting must be protected against mechanical damage, moisture, dirt and dust. The storage temperature range is 10 – 40°C.
- Avoid UV radiation and direct sunlight.
- Leave the fitting in its original packaging to ensure the best possible protection.
- Dispose of the packaging material according to disposal requirements/environmental protection regulations.



Warning

3 Technical Data

3.1 Dimensions 5A630G

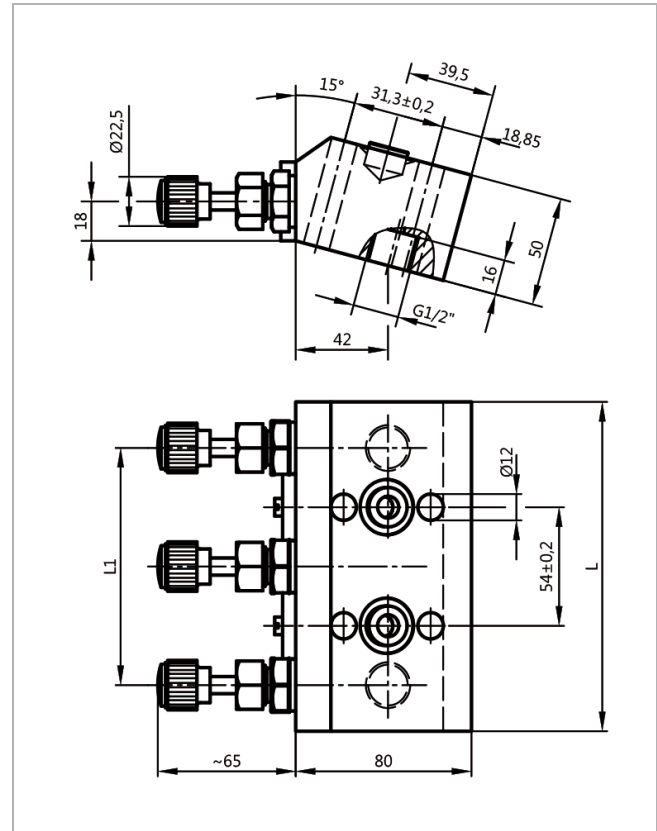

	G	L	L1
5A630G03...	G 1/2"	150	108
5A630G05...	G 1/2"	260	210

All data in mm

Missing dimensions can be found on our homepage under the following link: www.em-technik.com

Special sizes can be asked via info@em-technik.com

3.2 Operating Medium

- Neutral, gaseous and liquid media that do not negatively affect the physical and chemical properties of the relevant housing and sealing material.
- If you have questions about resistance please contact **emtechnik**.
- For the maximum permitted operating pressure/temperature see the pressure guide.

3.3 Pressure Guide

As the temperature rises, the effectiveness of the fitting falls, as shown by this table.

Material	PP	PVDF	PTFE
Pressure Stage	PN 10	PN 10	PN 6
-40°C		75%	75%
-20°C		100%	100%
5°C	100%	100%	100%
20°C	100%	100%	100%
30°C	80%	80%	80%
40°C	70%	70%	70%
50°C	60%	60%	60%
60°C	50%	50%	50%
70°C	40%	45%	40%
80°C	30%	40%	30%
90°C	20%	35%	30%
100°C		35%	30%
110°C		30%	35%
120°C		25%	25%
130°C		25%	25%
140°C		10%	20%
150°C			10%

4 Assembly and Operation

4.1 Assembly Instructions

- Make certain the fitting is suitable for the relevant application. The fitting must be suitable for the operating conditions of the pipeline system (medium, concentration, temperature and pressure) as well as the relevant ambient conditions.
- Check the fitting for transport damage before installing it. If the fitting is damaged do not install it.
- The planner, the construction company or operating company are responsible for the positioning and installation of the fitting. Planning and installation errors can adversely affect the reliable functionality of the fitting and may represent a significant potential for hazard.
- After the fitting is installed perform a tightness and function check.



4.2 Tools Required

The tools required for installation and assembly are not included with delivery.

4.3 Connecting the Transmitter Valve

- The fitting must be connected to the pipeline so it is free of mechanical stress.
- The transmitter valve has a female thread (ISO, DIN, ANSI) and can be connected with various connecting elements of the emtechnik system.



Cylindrical thread		Conical thread
Sealing is provided by a sealing collar for Cylindrical threads (G, M or UNF). A version with an O-ring is also possible.		Sealing is provided by the thread itself for Conical threads (NPT).
Sealing Collar	O-Ring	Thread

- Each thread must always be connected with the same thread type.
- If a plastic fitting is used in combination with a metallic male fitting, additional sealing with Teflon® tape is recommended.



5 Commissioning

5.1 Precondition for Commissioning

- Protect against leaks: Take protective measures against exceeding the maximum permitted pressure due to possible pressure surges.
- Check the tightness and function of the fitting.
- In new systems and after repairs, flush the line system to remove foreign materials.



5.2 Operation

Turn handwheel clockwise to close the transmitter valve. Turn the handwheel counterclockwise to open the transmitter valve.

5.3 Diagram

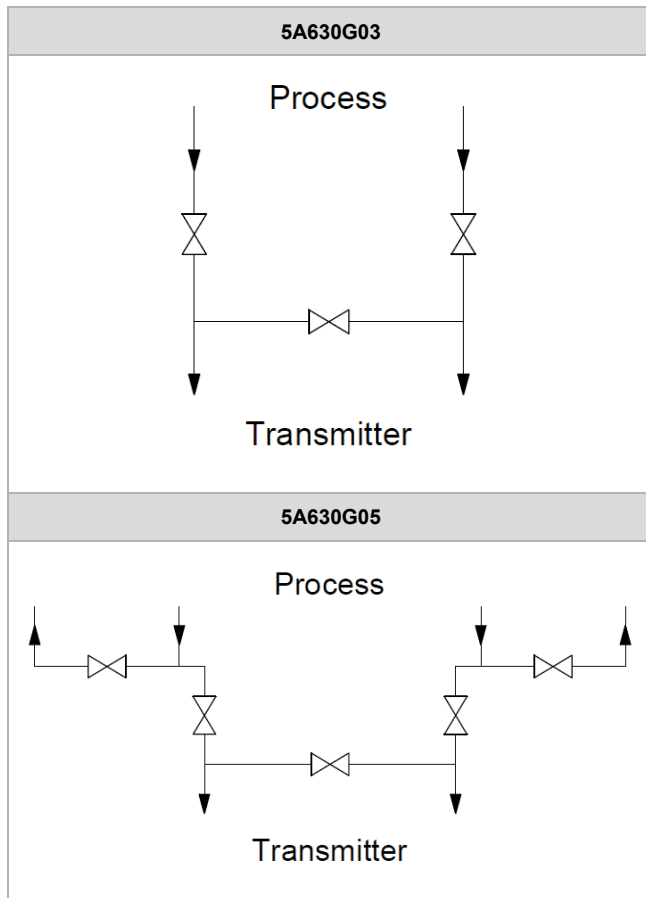

6 Maintenance

- When used as designated, the fitting is practically wear-free and generally requires no maintenance.
- The operating company must perform regular visual inspections of the fitting according to the operating conditions to prevent leaks and damage.

7 Disposal

- When disposing of the fitting and packaging, comply with the relevant disposal requirements and environmental protection regulations.
- When disposing of fittings, pay careful attention to any residues of toxic or corrosive media.



Warning

8 Return Delivery

Do not return before consulting with **emtechnik**.



1. Please consult with **emtechnik**.
2. Empty the fitting properly.
3. Rinse and clean the fitting thoroughly, especially if the media is being conveyed are harmful, explosive, hot, or hazardous in some other way.
4. For fittings that have been operated with aggressive, corrosive, combustible, toxic or water polluting media, a completely filled in clearance certificate must always be included.

9 Troubleshooting / Fault Rectification

Error	Possible Cause	Error Rectification
The fitting does not open/close or not completely	Foreign object in the fitting	Flush the fitting
Connection between fitting and pipeline is leaking	Sealing surface damaged	Use sealant
Fitting is leaking	Fitting faulty	Check fitting for damage and replace it if necessary

10 Manufacturer's Declaration

- Our products do not fall under the scope of the Machinery Directive 2006/42/EC. However, they can be incorporated in an installation that is considered as machinery. In this case regard the following note: The products may not be put into operation until it is made sure that the final machinery into which our products are incorporated complies with the provisions of the Machinery Directive 2006/42/EC.
- Based on the fluid class, pressure and nominal diameter, our products fall under diagram 8 of the Pressure Equipment Directive PED 2014/68/EU. Because of the ratio of nominal diameter, pressure and volume, they fall only under article 4 paragraph 3 and are designed and manufactured according to applicable good engineering practice. They must not carry any CE marking.

- The warranty of armature expires in the following cases: Operating conditions which do not follow the intended use or do not follow technical specifications. Improper installation or assembly. Just as well as inappropriate use, dismantling or modification.
- Failure to observe information provided here may lead to injuries, material damage, malfunctions and impurities due to escaping medium.



Warning

11 Contact

In case of questions or suggestions please contact us:

EM-Technik GmbH

Industriestr. 2	Tel +49 6237 407-0
67133 Maxdorf	Fax +49 6237 407-77
Germany	info@em-technik.com